

Varenummer: 2310431057S  
Beskrivelse: E+G Stilleben  
LX.30-SW17-M8X18-S

## Mål

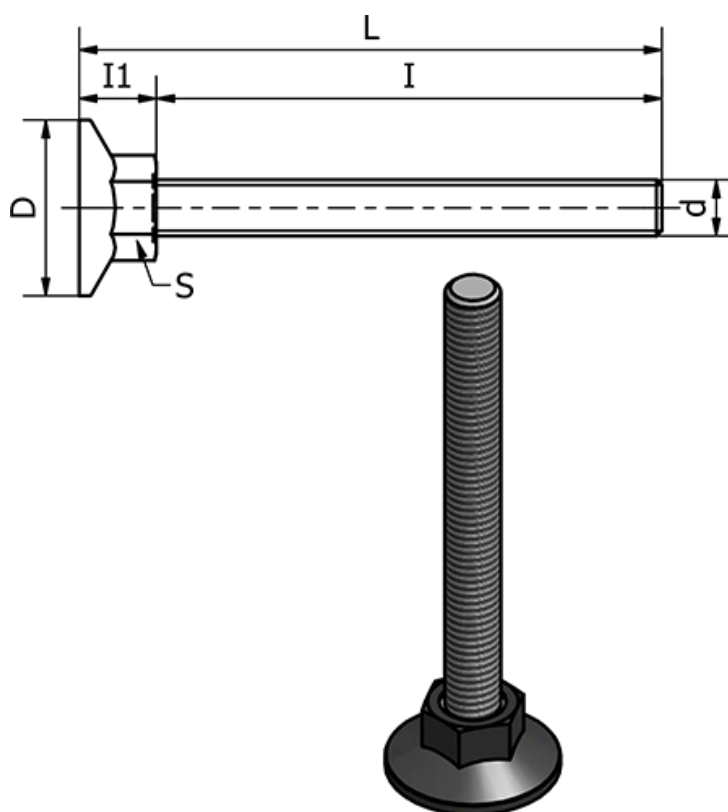

d	= M8
D	= 30
I	= 18
I1	= 12
L	= 30
Max statisk belastning (N)	= 2500
S	= 17
Type	= Forzinket

Vægt (g) = -